

This document downloaded from
vulcanhammer.net

since 1997,
your source for engineering information
for the deep foundation and marine
construction industries, and the historical
site for Vulcan Iron Works Inc.

Use subject to the “fine print” to the
right.

Don't forget to visit our companion site <http://www.vulcanhammer.org>

All of the information, data and computer software ("information") presented on this web site is for general information only. While every effort will be made to insure its accuracy, this information should not be used or relied on for any specific application without independent, competent professional examination and verification of its accuracy, suitability and applicability by a licensed professional. Anyone making use of this information does so at his or her own risk and assumes any and all liability resulting from such use. The entire risk as to quality or usability of the information contained within is with the reader. In no event will this web page or webmaster be held liable, nor does this web page or its webmaster provide insurance against liability, for any damages including lost profits, lost savings or any other incidental or consequential damages arising from the use or inability to use the information contained within.

This site is not an official site of Prentice-Hall, the University of Tennessee at Chattanooga, Vulcan Foundation Equipment or Vulcan Iron Works Inc. (Tennessee Corporation). All references to sources of equipment, parts, service or repairs do not constitute an endorsement.

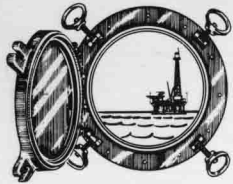

OFFSHORE PRODUCTS DIVISION

VULCAN IRON WORKS INC.

SPECIFICATIONS

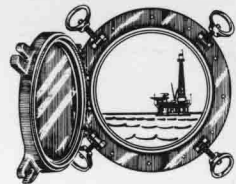

OFFSHORE CABLE TYPE PILE HAMMER

Size 020

Model No. 08F100 Spec. No. 2105

OPERATING DATA

Rated Striking Energy.....	60,000 Ft. Lb.....	8,298 kg m
Blows Per Minute @ Rated Pressure.....	60.....	60
Nominal Stroke.....	3 Ft.....	914 mm
Striking Velocity @ Impact.....	13.94 FPS.....	4.25 m/sec.
Max Force @ Impact.....	8,660,250 Lb.....	3,936,477 kg
Rated Operating Pressure @ Hammer.....	120 p.s.i.....	8.44 kg/cm ²
Steam Consumption-From & @ 212° F./100° C.....	7,500 Lb./hr.....	3,402 kg/hr.
Air Consumption — (Adiabatic Compression).....	1,634 CFM.....	46.24 cu m/min.
Boiler H.P. Req'd. — ASME Rating.....	217 USHP.....	220 MHP
√EW Rating @ Energy Rating.....	34,641.....	34,641

DIMENSIONAL DATA

Diameter of Piston.....	21 3/4 In.....	552 mm
Area of Piston — Net.....	335.75 Sq. In.....	2,166.18 cm ²
Length of Hammer — Overall.....	14'-8".....	4,470 mm
Distance Across Male Jaws.....	54 In.....	1,372 mm
Width of Male Jaws.....	10 1/4 In.....	260 mm
Largest Diameter of Pile*.....	48 In.....	1,219 mm
Size of Hose.....	3 In.....	75 mm

WEIGHT DATA

Weight of Striking Parts.....	20,000 Lb.....	9,091 kg
Net Weight of Hammer.....	43,785 Lb.....	19,902 kg
Shipping Weight of Hammer.....	45,000 Lb.....	20,417 kg

*Permitted by Standard Jaws

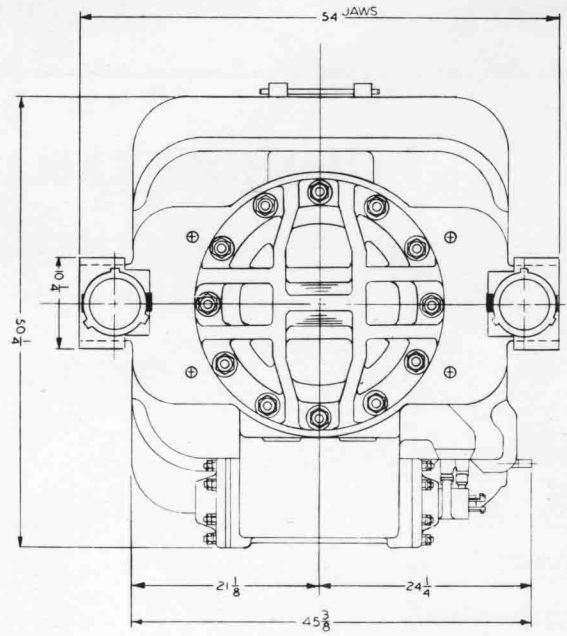
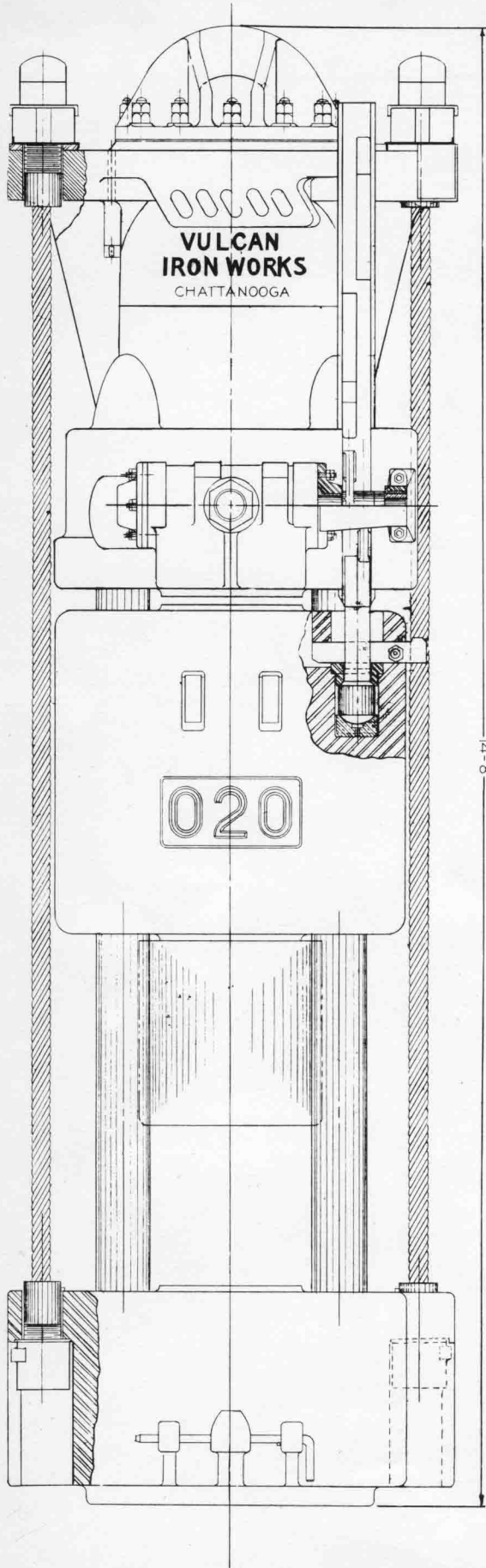

**CYLINDER HEAD
OPTIONS**

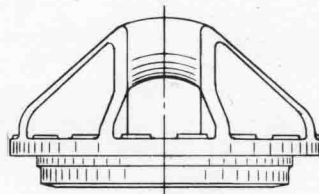

BAR TYPE

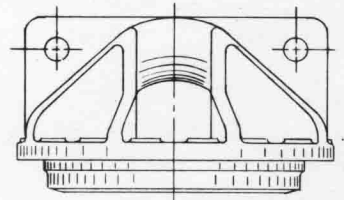

SUSPENSION TYPE

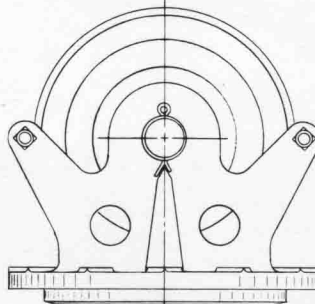

SHEAVE TYPE

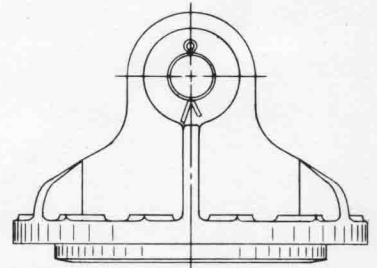

SAND DRAIN TYPE